

Article number: 439500050
 Description: Rota-fix shaft-hub connection F50x80
 Steel
 Note: Self centering. Very high torque

Measures

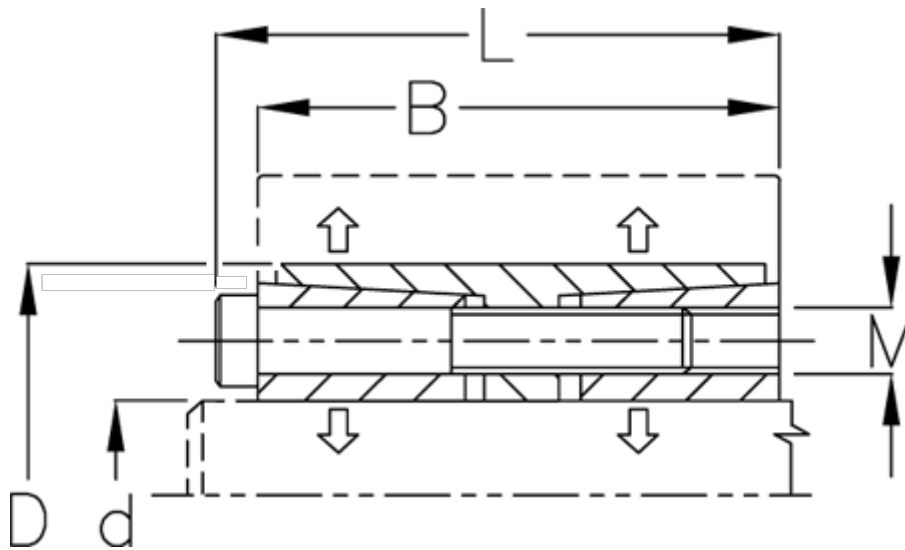

B mm	= 62
d H8 mm	= 50
D mm	= 80
Fit tolerance	= Aksel h8, Nav H8
F kN torque	= 140.0
L mm	= 70
M mm	= M8
P N/mm ² surface pressure on shaft/hub	= 80

Surface roughness	= R? ? 3.2 µm
T N m torque	= 3600
Ts N m bolt tightening torque	= 41.0